



egoè

Značka Egoé vznikla z přirozené lidské touhy – udělat si něco pro sebe. Jediným zadáním bylo uspokojit své vlastní uživatelské a estetické potřeby. Myslet taky jednou i na někoho jiného, než na ostatní.

EN The Egoé brand originated from the natural human desire to make something for themselves. The only constraint was to satisfy their own aesthetic needs and usage. To put themselves in the forefront for once, rather than someone else.

DE Die Marke Egoé entstand durch die natürliche menschliche Leidenschaft – etwas für sich selber zu erstellen. Die einzige Aufgabe war die Bedürfnisse der Benutzer, der Ästhetik und der von sich selber zu befriedigen. Einmal auch an jemanden anderen als an sich selber zu denken.

Alva	4
Axis	10
Back to fire	14
Barka	18
Bistrot bar	22
Bistrot	26
Cora	34
Desa	42
Laso	46
Laurede	52
Leva	56
Limpido	60
Máj	66
Mario	70
Mini Vera	74
Moja	78
Preva	84
Radium	90
Salto	96
Sena	100
Sombra	104
Tina	108



design  
David Karásek  
Radek Hegmon

LAL417

# Alva







LAL457



LAL415



LAL457

design  
David Karásek  
Radek Hegmon

LA125

# Axis





LA540, LA155



LA155



# Back to fire





# Barka





BA120



BA110, BA120



design  
David Karásek  
Radek Hegmon

LBS920, LBS180

# Bistrot bar





LBS920, LBS180



LBS920, LBS180

design  
David Karásek  
Radek Hegmon

LBS230

# Bistrot

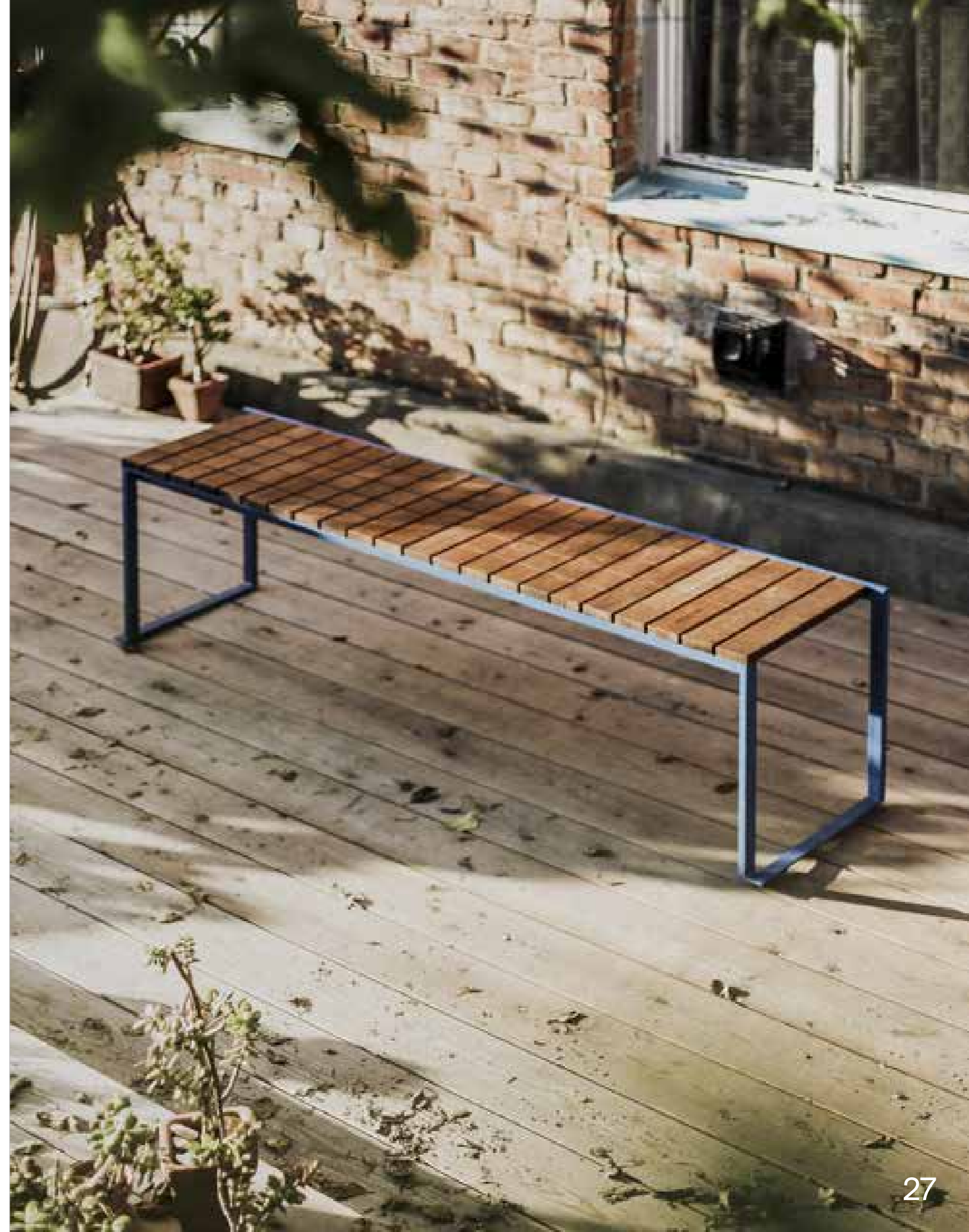



LBS225, LBS226, LBS227

LBS225





LBS215



LBS210



LBS210, LBS620



LBS230, LBS630

# Cora





LCR120



LCR125





LCR125, LCR630



LCR128



LCR615, LCR125



LCR127

# Desa





DE100



DE101

# Laso







LAS100



LAS101



LAS100, LAS101



LAS100, LAS101

design  
Ruud van Eggelen

LU240

# Laurede





LU240, LU530

LU140, LU240



design  
Luděk del Maschio

# Leva

LEV120, LEV200, LEV300







LEV120, LEV200, LEV300, LEV400



LEV120

design  
Roman Vrliška

LLP156

# Limpido





LLP105, LLP135



LLP105, LLP135



LLP126

design  
Atelier Pelcl

MA102, MA105

# Máj







MA102

MA100, MA102, MA103, MA 105

# Mario





MAR220

design  
David Karásek  
Radek Hegmon

LVE162, LVE930

# Mini Vera





LVE150



LVE162, LVE930



# Moja





MO110



MO120



MO110, MO120



MO120

# Preva





LP355, LP365



LP375





LP365, LP365

# Radium





LRE115



LRE450



LRE115, LRE350

design  
studio plusko  
Jitka Trčková

SAL100

# Salto







SAL200



SAL100

# Sena





SN100



SN123

# Sombra

SOD110  
SOD zadní zástěna / back screen / Rückwand, SOD boční zástěna / side screen / Seitenwand, SOD grill









design  
studio plusko

KL100, KL102, KL106

# Tina





KL105



KL104



KL100. KL106



EDO302

EDO300, EDO301

bez protiskluzu  
without antislip  
ohne Anti-Rutsch

s protiskluzem  
určeno jako sedák na židli  
with antislip  
designated as chair seat  
mit Anti-Rutsch als Kissen für einen  
Stuhl bestimmt



EDO300 160 × 140 cm



EDO301 70 × 70 cm



EDO302 45 × 45 cm



EDO303 45 × 45 cm





EDO202

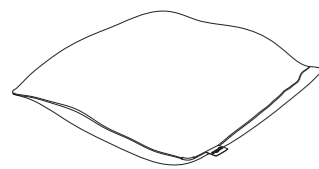

EDO200 55 × 55 cm

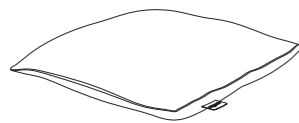

EDO201 43 × 43 cm

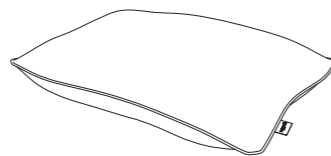

EDO202 60 × 40 cm



EDO101

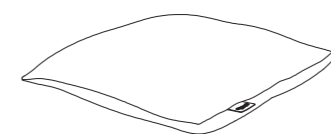

EDO100 55 × 55 cm



EDO101 43 × 43 cm

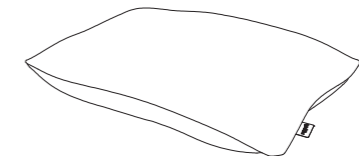

EDO102 60 × 40 cm





EDO041



EDO041, EDO042 →

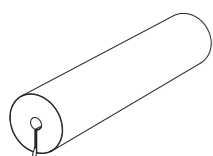

EDO041 Ø 7,2 × 36 cm

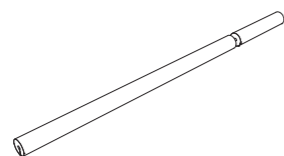

EDO042 Ø 7,2 × 117,5 cm



EDO018  
EDO011 →

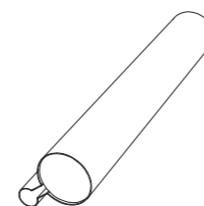
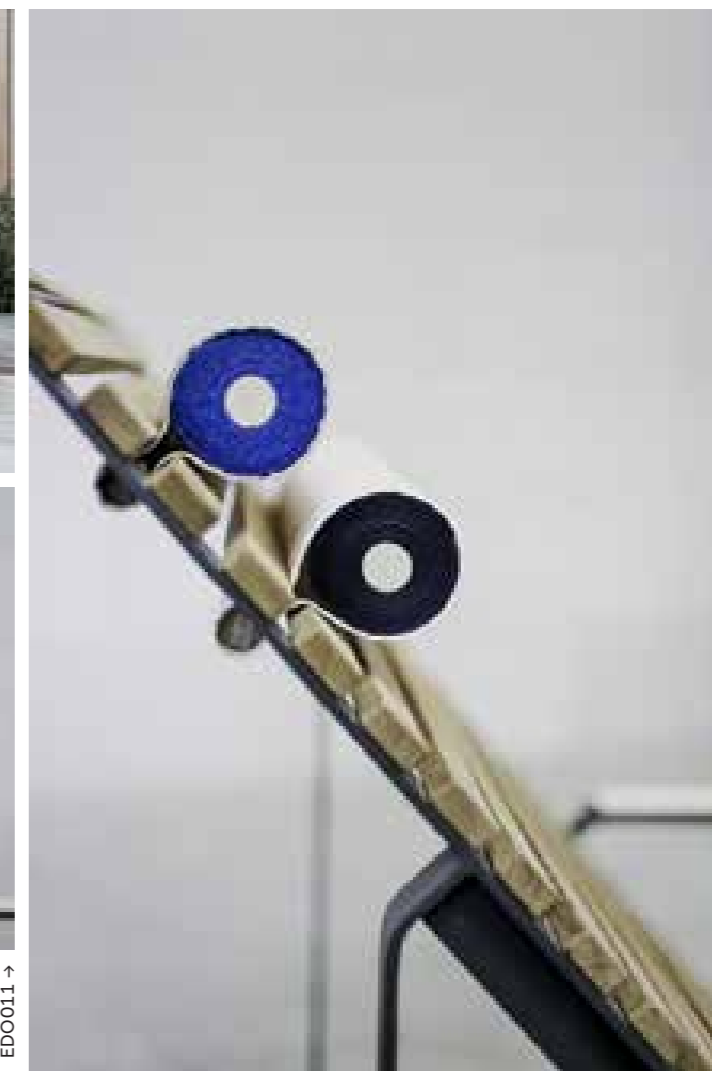

EDO011 Ø70 × 45 cm

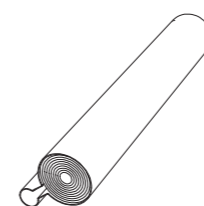

EDO017 Ø70×45 cm



EDO050

určeno pro všechny BA  
designated for all BA  
bestimmt für alle BA

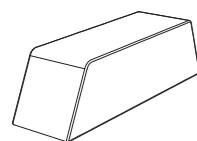

EDO50 13,5 × 49 × 15 cm



EDO021



set 7 ks, určeno pro KL100, KL105  
7 pc set, designated for KL100, KL105  
Set 7 Stk., bestimmt für KL100, KL105

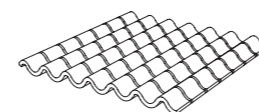

EDO021 61 × 5 × 1 cm



EDO030

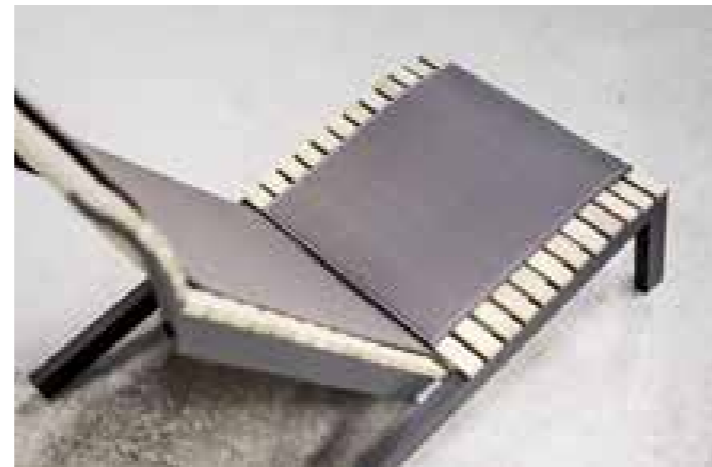

EDO030  
EDO040 →

určeno pro LAL315, LAL325  
designated for LAL315, LAL325  
bestimmt für LAL315, LAL325

určeno pro LAL455  
designated for LAL455  
bestimmt für LAL455

určeno pro LAL415  
designated for LAL415  
bestimmt für LAL415

určeno pro LBS410  
designated for LBS410  
bestimmt für LBS410

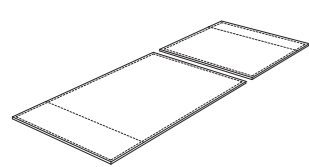

EDO030 44,5 × 81,5 × 50 × 0,8 cm

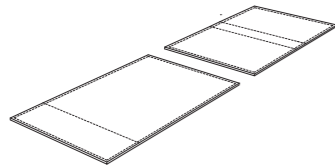

EDO031 44,5 × 81,5 × 81,5 × 0,8 cm

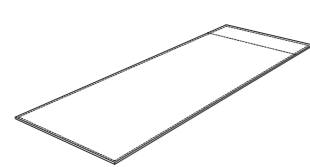

EDO032 53,5 × 170 × 0,8 cm

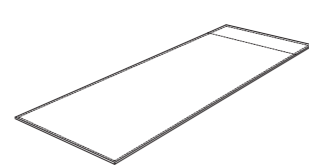

EDO040 53,5 × 170 × 0,8 cm

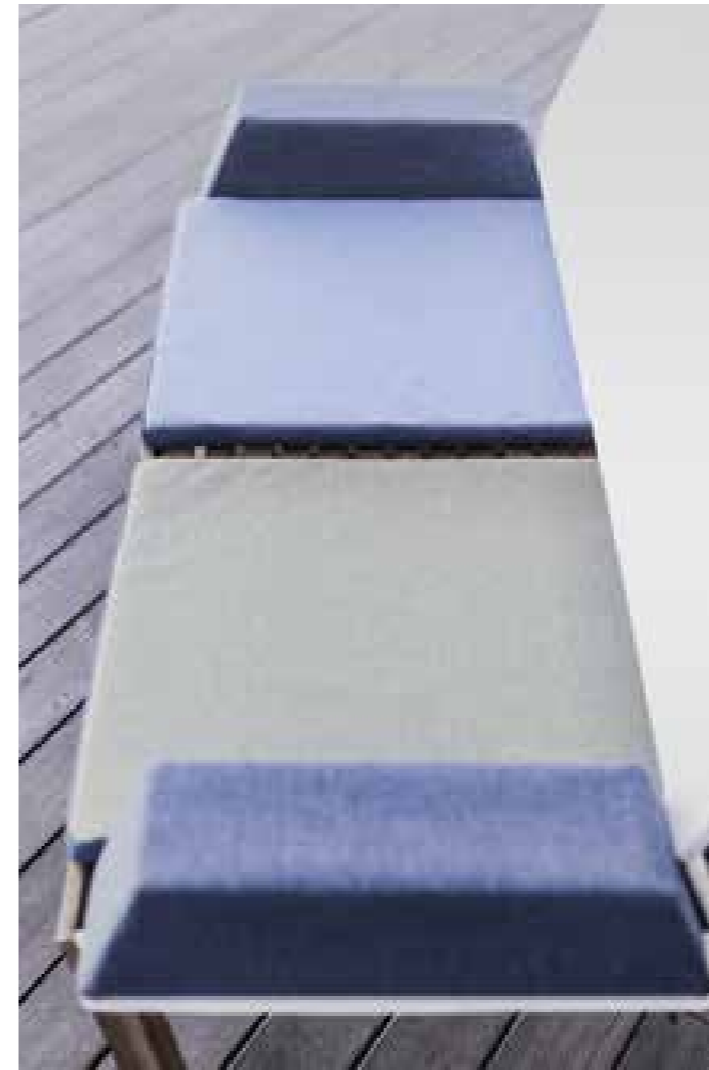

EDO051, EDO050



EDO51

určeno pro LP365  
designated for LP365  
bestimmt für LP365

určeno pro LP355  
designated for LP355  
bestimmt für LP355

určeno pro LP375  
designated for LP375  
bestimmt für LP375

určeno pro všechny BA  
designated for all BA  
bestimmt für alle BA

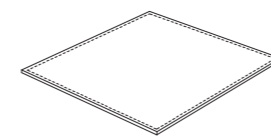

EDO017 45 × 50 × 0,8 cm

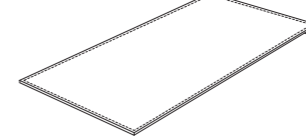

EDO015 45 × 100 × 0,8 cm

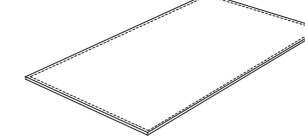

EDO013 45 × 87 × 0,8 cm

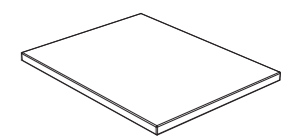

EDO051 54 × 71 × 4 cm

# Vzorník RAL / RAL Swatch / Farbenmustermappe RAL

bílá / white / weiss 9010	slonová kost sv. / light ivory / elfenbein 1015	žlutá hořčičná / rape yellow / rapsgelb 1023	oranžová pravá / orange / reinorange 2004
sv. růžová / light pink / hellrosa 3015	červená / red / verkehrsrot 3020	nachová / pink / telemagenta 4010	modrý capri / capri blue / capriblau 5019
sv. zelená / light green / lichtgrün 6027	stínová šedá / umbra grey / umbragrau 7022	sv. šedá / light grey / lichtgrau 7035	

# HPL

bílá / white / weiss matt 819	světle šedá / light grey / hellgrau 0741 NT	středně šedá / medium grey / mittelgrau 0747 NT	tmavě šedá / dark grey / dunkelgrau 0077 NT
žlutá / yellow / gelb 1886 CS	červená / red / rot 0689 NT	modrá / blue / blau 0717 NT	

# Dřevo / wood / Massiv

Akát s olejem / acacia with oil / Akazie mit Öl

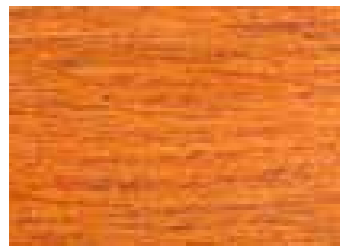

Akát / acacia / Akazie



Ipe s olejem / Ipe with oil / Ipe mit Öl

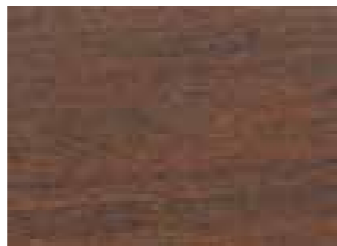

Ipe / Ipe / Ipe

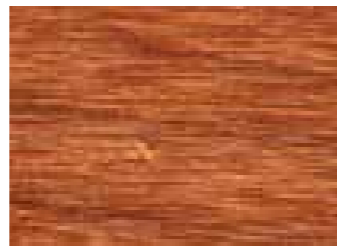

# Textilie / textile / Textilien

oranžová / orange / orange

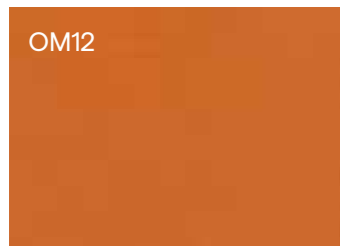

červená / red / rot

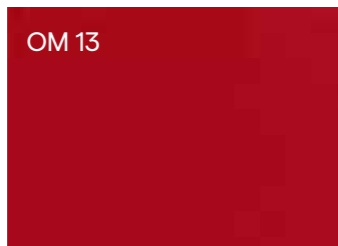

antracitová / anthracite / anthrazit

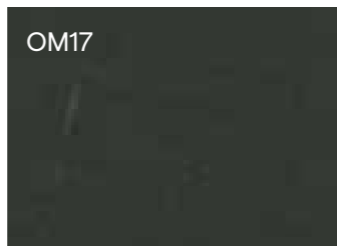

černá / black / schwarz

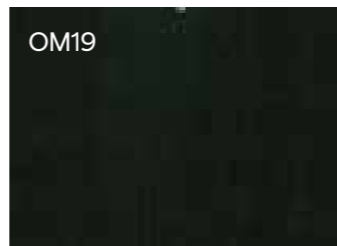

tyrkysová / turquoise / türkisblau

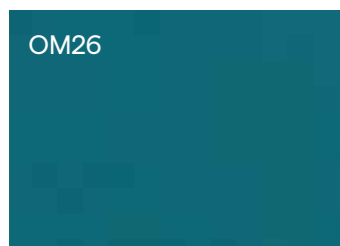

světle šedá / light grey / hellgrau

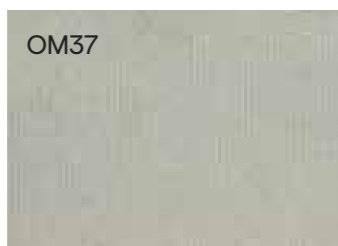

taupe

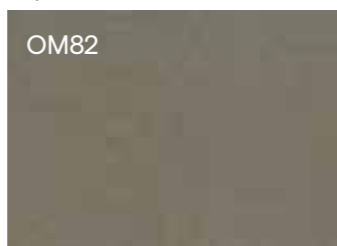

taupe

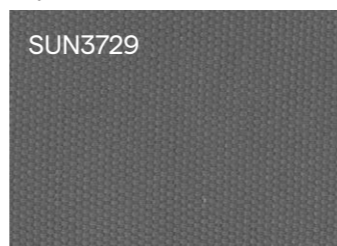

šedá / grey / grau

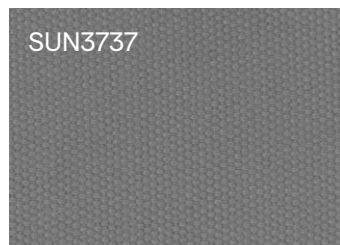

černá / black / schwarz

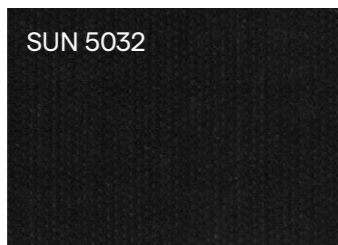

tmavě hnědá / dark brown / dunkelbraun

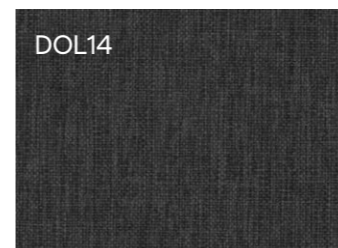

tmavě modrá / dark blue / dunkelblau

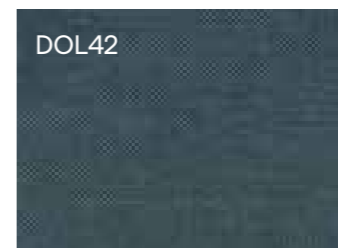

modrá / blue / blau

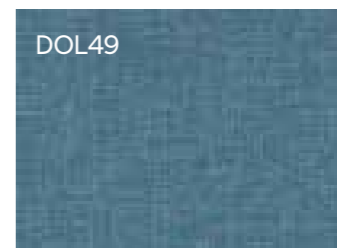

světle zelená / light green / lichtgrün



tmavě modrá / dark blue / dunkelblau

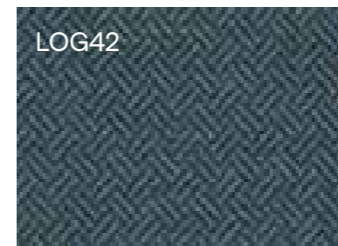

šedá / grey / grau



šedá / grey / grau

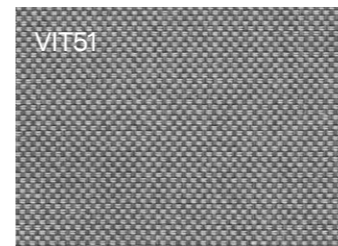

taupe

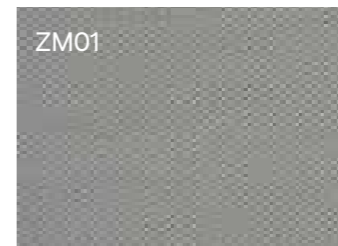

žlutá / yellow / gelb

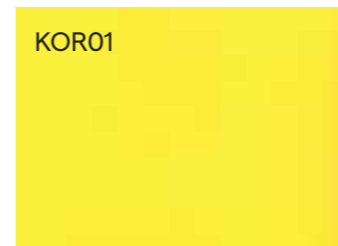

červená / red / rot

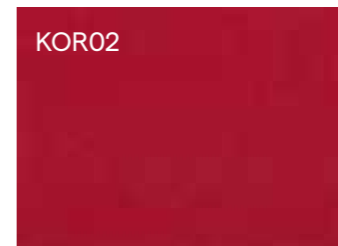

tmavě modrá / dark blue / dunkelblau

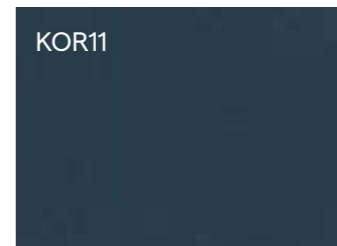

tmavě šedá / dark blue / dunkelblau

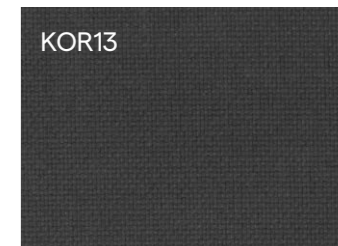

růžová / pink / hellrosa

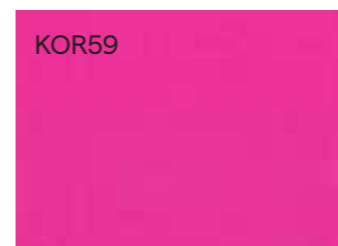

zelená / green / grün

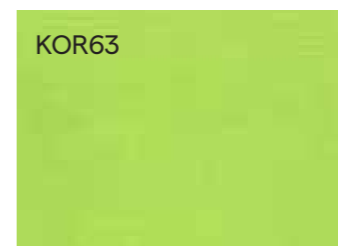

světle květovaná / light flowered / helles Blumenmuster



tmavě květovaná / dark flowered / dunkles Blumenmuster



pruhovaná / striped / gestreift

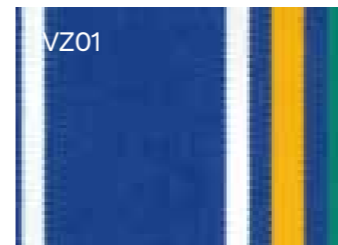

caracola



květovaná / flowered / Blumenmuster





Batyline / Batyline / Batyline

Žíhaná bílo-šedá / white grey / weiss-grau

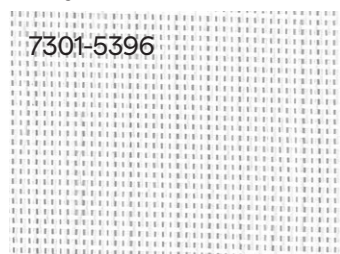

zelená / green / grau

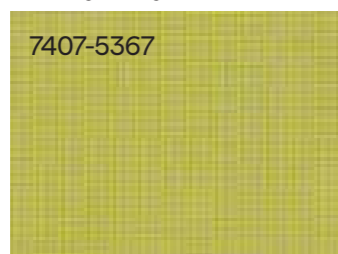

bílá / white / weiss



černá / black / schwarz

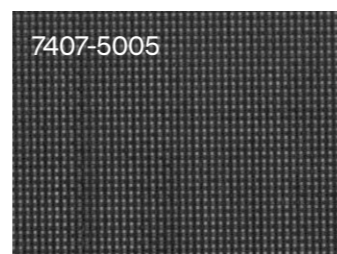

běžová / beige / beige

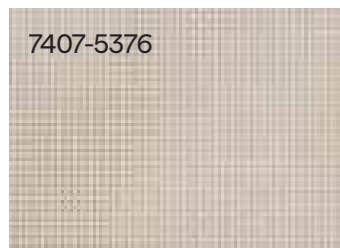

žlutá / yellow / gelb

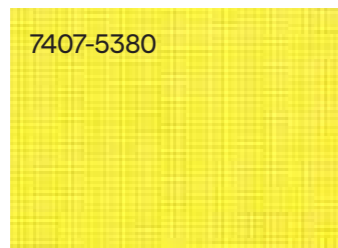

červeno-oranžová / reddish-orange / rot-orange

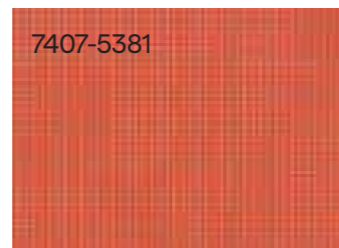

taupe



Ostatní / others / Andere

ART coal černá / black / schwarz



ART ecru béžová / beige / beige

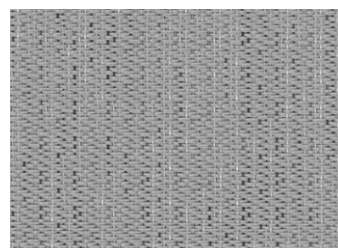

ART malachite zelená / green / grün



ART slate šedá / grey / grau

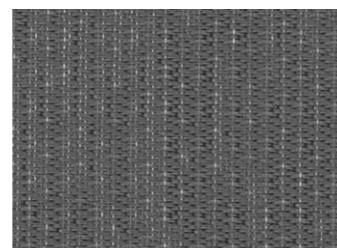

PUR oranžová / orange / orange



PUR růžová / pink / hellrosa



PUR žlutá / yellow / gelb

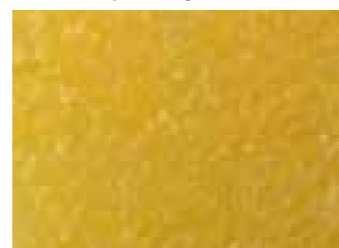

Velcro červená / red / rot

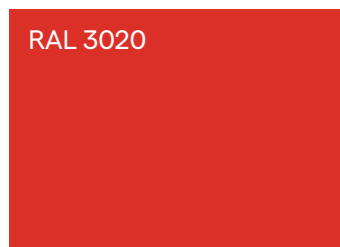

Velcro černá / black / schwarz

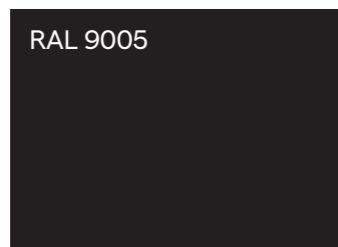

# Alva

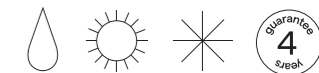

CZ Hliníková konstrukce je povrchově dokončena práškovou barvou. Sedací a lehací část je vyrobena ve variantách z masivu nebo outdoorové síťoviny Batyline. Nábytek je stohovatelný a díky své lehkosti je zaručena dobrá manipulace.

EN Aluminum structure with powder coating finish. The sitting and lying part is made from solid wood or the Batyline outdoor fabric. The products are stackable. The light structure ensures easy manipulation.

DE Die Konstruktion aus Aluminium wurde oberflächlich mit Pulverfarbe beschichtet. Der Sitz- und Liegeteil wird in den Varianten aus Massivholz oder Outdoor- Geflechte aus Batyline hergestellt. Die Möbelstücke sind stapelbar und dank ihrer Leichtigkeit ist eine leichte Manipulation gesichert.

+ Doporučujeme kombinovat s těmito produkty

We recommend to combine them with these products

Wir empfehlen die Kombination mit diesen Produkten.

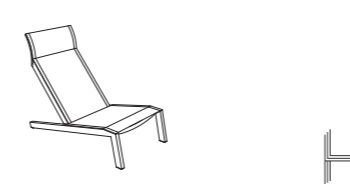

LAL317 59 × 109,5 × 82,5 cm

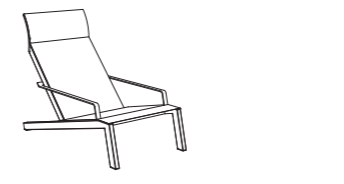

LAL327 59 × 109,5 × 82,5 cm

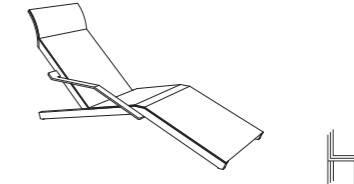

LAL457 64 × 160 × 79 cm

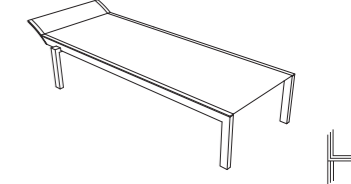

LAL417 76 × 195 × 45 cm



LAL315 59 × 108 × 83 cm



LAL325 59 × 108 × 83 cm

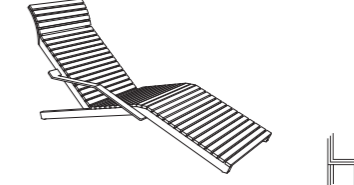

LAL455 64 × 158 × 79,5 cm

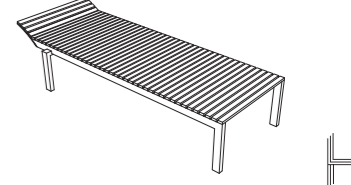

LAL415 76 × 195 × 46 cm



+ MA103 Ø 33 × 55 cm

# Axis

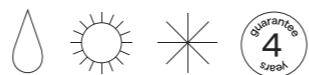

CZ Konstrukce je vyrobena z pozinkovaných ocelových profilů, které jsou povrchově dokončeny práškovou barvou. Sedací i stolová část je vyrobena z lamel tropického dřeva nebo akátu. Židle, křesla i lavice lze stohovat.

EN Structure made of galvanized steel profiles with powder coating finish. Seating and table top are made from tropical wood or acacia slats. Chairs, armchairs and benches are stackable.

DE Die Konstruktion wurde aus verzinkten Stahlprofilen hergestellt, welche mit Pulverfarbe beschichtet wurden. Die Sitz- sowie Tischfläche besteht aus tropischen Holzlamellen oder Akazienholzlamellen. Die Stühle, Tische sowie Bänke sind stapelbar.



**LA125** 50 × 67 × 87 cm



**LA135** 57 × 67 × 87 cm



**LA155** 67 × 72 × 76 cm



**LA245** 120 × 72 × 76 cm



2-4x  
😊

**LA540** 112 × 43 × 42 cm

# Barka

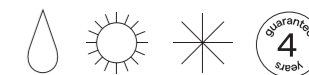

CZ Opěradlová část je vyrobena z pozinkovaných pásovin, které jsou povrchově dokončeny práškovou barvou a opatřeny outdoorovou síťovinou Batyline. Zbýlá konstrukce je vyrobena z tvrdého tropického dřeva nebo akátu.

EN The backrest is made of galvanized steel strips with a powder coated surface finish and provided with the Batyline outdoor mesh. The rest of the structure is made of hard tropical wood or acacia.

DE Die Lehne wird aus verzinkten Barren, welche oberflächlich mit Pulverfarbe und der Outdoor - Textilie Batyline fertiggestellt sind, hergestellt. Der restliche Teil der Konstruktion besteht aus tropischem Hartholz oder aus Akazienholz.

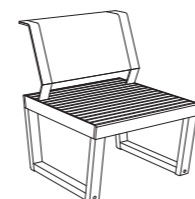

**BA110** 67 × 69 × 83 cm

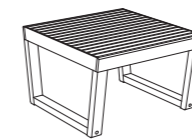

**BA112** 67 × 69 × 42 cm

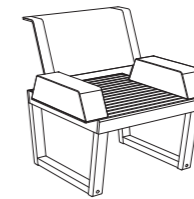

**BA115** 80 × 69 × 82 cm

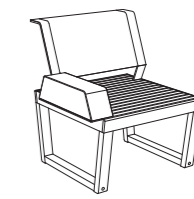

**BA116** 73,5 × 69 × 82 cm

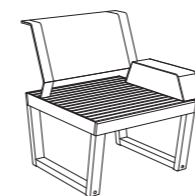

**BA117** 73,5 × 69 × 82 cm

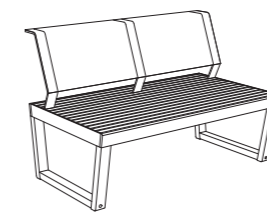

**BA120** 128 × 69 × 82 cm

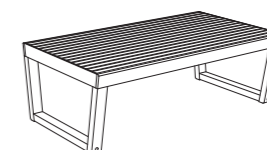

**BA122** 128 × 69 × 42 cm

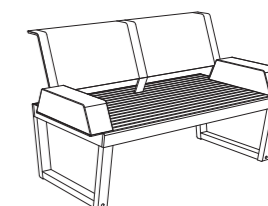

**BA125** 141 × 69 × 82 cm

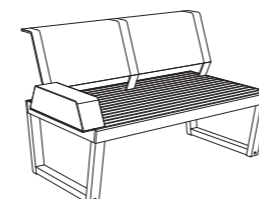

**BA126** 134,5 × 69 × 82 cm

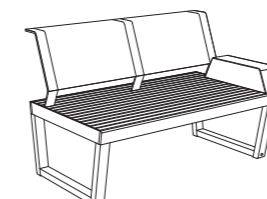

**BA127** 134,5 × 69 × 82 cm

# Back to fire

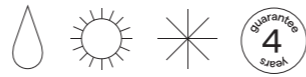

CZ Ohniště i grily jsou vyrobeny z oceli, která je povrchově dokončena žáruvzdornou barvou. Nohy grilů, boční police i madla roštů jsou z akátu. Grilovací rošty jsou vyrobeny z nerez. Kotlíkový set se skládá z ocelové trojnožky, litinového kotlíku a smaltované pokličky.

EN Fireplaces and grills are made of steel with a refractory coating. Grill legs, side shelves and grate grips are made of acacia wood. Grill grids are made of stainless steel. The pot set consists of a steel tripod, a cast iron kettle and enamel lid.

DE Die Feuerstellen und die Grille sind aus Stahl, welcher oberflächlich mit feuerfester Farbe behandelt wurde. Die Beine der Grille, die Seitengestelle und die Griffe der Roste sind aus Akazienholz. Die Grillroste sind aus Edelstahl. Das Kessel-Set besteht aus einem Dreibein aus Stahl, einem gusseisernen Kessel und einem emaillierten Deckel.

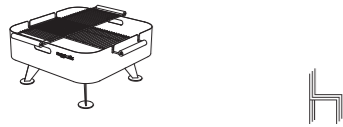

**GRL100** 59 × 59 × 31 cm

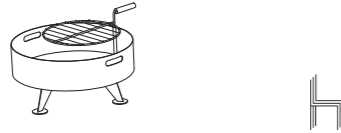

**GRL101** Ø 61 × 30,5 cm



**GRL102** 97,5 × 41 × 69 cm

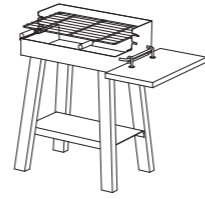

**GRL103** 101 × 60 × 92,5 cm

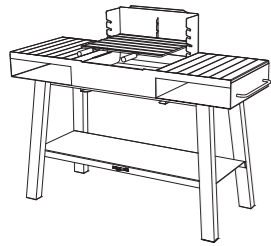

**GRL104** 152,5 × 54 × 115 cm

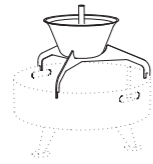

**GRL105** 55 × 47 × 400 cm

objem kotlíku 7,2 l  
Kettle volume 7,2 l  
Volumen des Kessels 7,2 l

# Bistrot bar

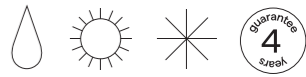

CZ Sedák a stolová deska barového setu jsou vyrobeny z vysokotlakého laminátu (HPL), konstrukce pak z oceli, která je pozinkovaná a povrchově dokončena práškovou barvou.

EN Seat and table top of this bar set are made of high pressure laminate (HPL), the structure is made of galvanized steel with powder coating finish.

DE Die Sitz- und Tischplatte dieses Bar-Sets wurde aus Hochdrucklaminat (HPL) hergestellt, die Konstruktion aus verzinktem, mit Pulverfarbe beschichtetem Stahl.

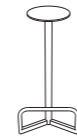

**LBS180** 31,5 × 36 × 74 cm

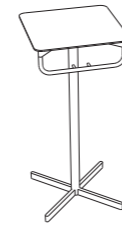

**LBS920** 52 × 52 × 111 cm

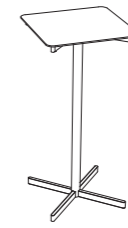

**LBS900** 52 × 52 × 111 cm

2-4x  
😊

2-4x  
😊

# Bistrot

CZ Taburety, lavice i lehátka jsou stohovatelné. Konstrukce je vyrobena z ocelových pozinkovaných profilů a pásovin, dokončených práškovou barvou. Materiálové varianty jsou tropické dřevo, akát nebo vysokotlaký laminát (HPL).

EN Stools, benches and chairs are stackable. The structure is made from galvanized steel profiles with powder coating finish. Material options: tropical wood, acacia or high pressure laminate (HPL).

DE Die Hocker, Bänke und Liegen sind stapelbar. Die Konstruktion besteht aus verzinkten Stahlprofilen und Stahlbändern, welche mit Pulverfarbe beschichtet wurden. Zwischen die Varianten des Materials gehört tropisches Holz, Akazienholz oder Hochdrucklaminat (HPL).

+ Doporučujeme kombinovat s těmito produkty  
We recommend to combine them with these products  
Wir empfehlen die Kombination mit diesen Produkten.

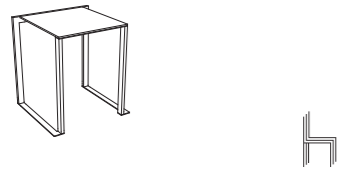
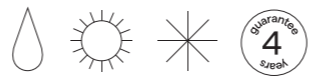

**LBS220** 43 × 39,5 × 46 cm

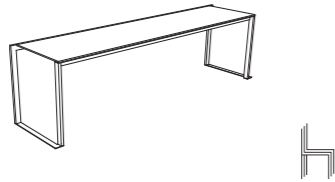

**LBS240** 165 × 39,5 × 46 cm

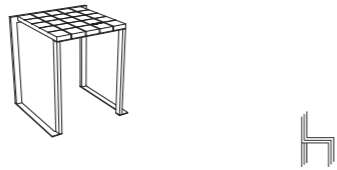

**LBS210** 43 × 39,5 × 46 cm

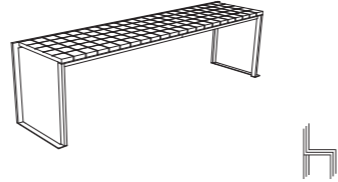

**LBS230** 165 × 39,5 × 46 cm



**LBS610** 95,5 × 95,5 × 75 cm

+ Cora + Tina + Axis



**LBS630** 166 × 95,5 × 75 cm

+ Axis + Tina + Cora



**LBS410** 76 × 188,5 × 45 cm

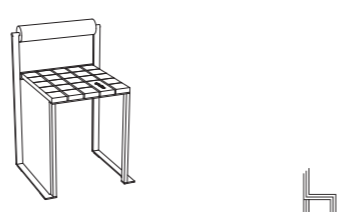

**LBS215** 43 × 39,5 × 67,5 cm

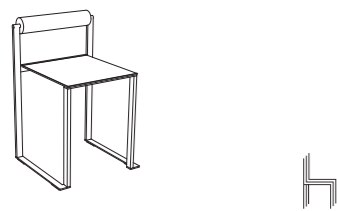

**LBS225** 43 × 39,5 × 67,5 cm

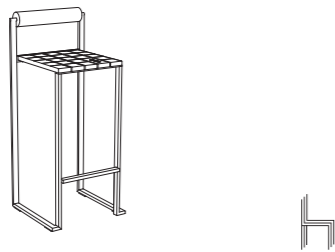

**LBS216** 43 × 39,5 × 100,5 cm

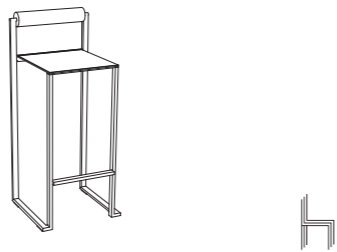

**LBS226** 43 × 39,5 × 100,5 cm

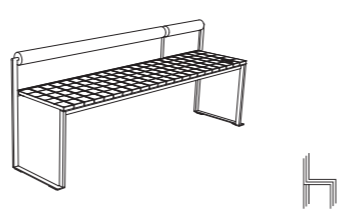

**LBS217** 165 × 39,5 × 67,5 cm

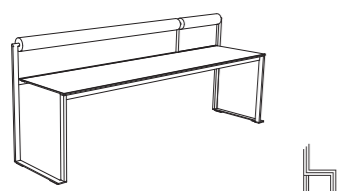

**LBS227** 165 × 39,5 × 67,5 cm



**LBS600** 80 × 60 × 112,5 cm

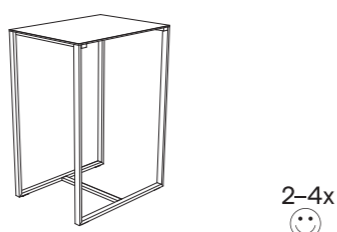

**LBS601** 80 × 60 × 110 cm



**LBS620** 95,5 × 95,5 × 40 cm

# Cora

CZ Hliníková konstrukce židlí i stolů je opatřena práškovou barvou. Sedací část židlí vyrábíme ve variantách masiv (tropické dřevo, akát), outdoorová síťovina Batyline nebo vysokotlaký laminát (HPL). Stolové desky mohou být zhotoveny z masivu (tropické dřevo, akát), nebo vysokotlakého laminátu (HPL).

EN Aluminium structure with powder coating finish. Seats made of wood (tropical wood or acacia), outdoor fabric Batyline or high pressure laminate (HPL). Table top made of tropical wood, acacia or high pressure laminate (HPL).

DE Die Konstruktion der Stühle und Tische besteht aus Aluminium und wurde mit Pulverfarbe beschichtet. Die Sitzfläche der Stühle kann in den Varianten Massivholz (tropisches Holz, Akazienholz), Outdoor-Geflechte aus Batyline oder Hochdrucklaminat (HPL) ausgeführt werden. Die Tischflächen könne aus Massivholz (tropisches Holz, Akazienholz) oder Hochdrucklaminat (HPL) gefertigt werden.

+ Doporučujeme kombinovat s těmito produkty  
We recommend to combine them with these products  
Wir empfehlen die Kombination mit diesen Produkten.

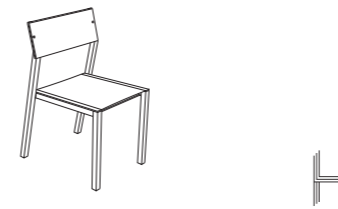
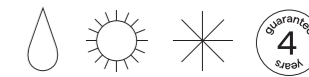

**LCR127** 49,5 × 58,5 × 84,5 cm

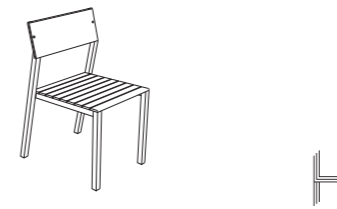

**LCR125** 49,5 × 58,5 × 84,5 cm

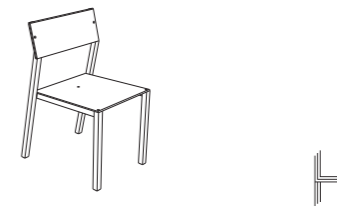

**LCR120** 49,5 × 58,5 × 84,5 cm

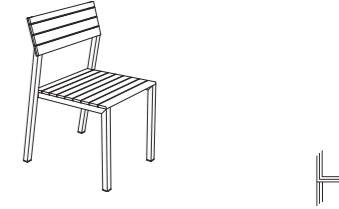

**LCR126** 49,5 × 58,5 × 84,5 cm

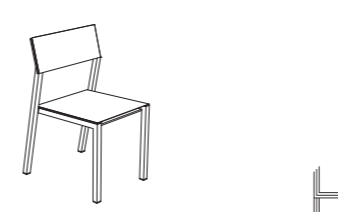

**LCR128** 49,5 × 58,5 × 84,5 cm



**LCR615** 86,5 × 86,5 × 76 cm

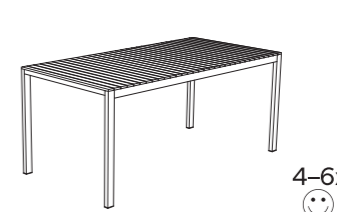

**LCR635** 174,5 × 86,5 × 76 cm

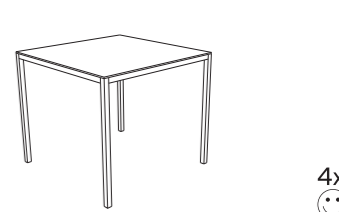

**LCR610** 86,5 × 86,5 × 75,5 cm

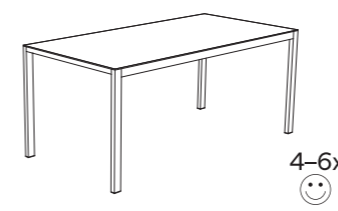

**LCR630** 174,5 × 86,5 × 75,5 cm

+ Bistrot

# Desa

CZ Stolová deska je vyrobena z vysokotlakého laminátu (HPL), která je připevněna na konstrukci stolů z tropického dřeva nebo akátu.

EN Table top made of high pressure laminate (HPL) attached to a structure made of tropical wood or acacia.

DE Die Tischplatte wurde aus Hochdrucklaminat (HPL) gefertigt und auf eine Konstruktion aus tropischem Holz oder aus Akazienholz fixiert.

+ Doporučujeme kombinovat s těmito produkty

We recommend to combine them with these products

Wir empfehlen die Kombination mit diesen Produkten.

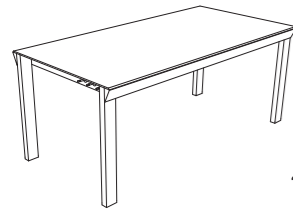

4-6x  
😊

**DE100** 180 × 95 × 75 cm

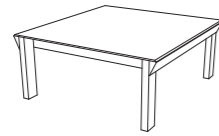

4x  
😊

**DE101** 100 × 100 × 40 cm

+ Cora + Tina + Limpido

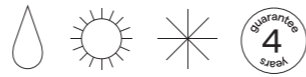

# Laso

CZ Exteriérové lampy Laso se skládají ze tří částí, které jsou vzájemně šroubovatelné. Propojující konektory v jednotlivých částech umožňují složení lampy do dvou typů – vysoké lampy a lampy nízké. Podstavec a nosná tyč je z oceli, která je pozinkovaná a povrchově dokončena práškovou pigmentovou barvou. Na podstavci se nachází nášlapný spínač, který je ukryt pod outdoorovým kobercem. Hliníkové stínidlo obsahuje LED pásky, které jsou zalaty akrylátovou pryskyřicí. Stínidlo je nastříkáno fotoluminiscenční barvou, která ve tmě svítí až 5h.

EN The exterior lamps from the Laso series consist of three components which can be screwed together. Thanks to the linking connectors attached to the individual parts you can easily switch the height of the lamp from taller to shorter. The base and the tube of the lamp are made out of zinc-coated steel with a power coated finish. On the base of the lamp you will find a foot switch covered with an outdoor carpet layer. The aluminium lamp shade contains LED strips coated with acrylic resin. The shade has also been sprayed with photoluminescent powder which can glow in the dark for up to five hours.

DE Die Aussenleuchten Laso bestehen aus drei Teilen, welche zusammengeschaubt werden. Die verbindenden Anschlüsse der einzelnen Teile ermöglichen das Zusammenbauen von zwei Typen – stehende Lampe oder niedrige Lampe. Der Sockel und die tragende Stange sind aus Stahl, welcher verzinkt ist und oberflächlich mit pigmentierter Pulverfarbe behandelt ist. Auf dem Sockel befindet sich ein Fusschalter, welcher unter einem Outdoor- Teppich versteckt ist. Der Lampenschirm aus Aluminium enthält LED- Streifen, welche mit Acrylharz übergossen sind. Der Lampenschirm ist mit einer fotoluminiszierenden Farbe angesprüht, welche in der Dunkelheit bis zu 5 Stunden leuchtet.

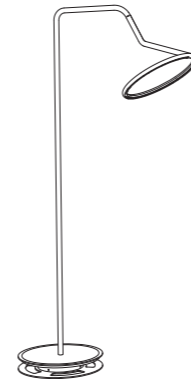

**LAS101** Ø 46 × 103 × 205



**LAS100** Ø 46 × 189,5

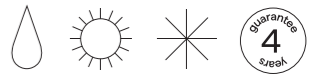



# Laurede

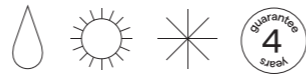

CZ Konstrukce je vyrobena z ocelových pozinkovaných profilů. Povrchová úprava je dokončena práškovou barvou. Sedací část i stolové desky jsou vyrobeny z tropického dřeva.

EN Structure made of galvanized steel profiles with powder coating finish. Seats and table tops made of tropical wood.

DE Die Konstruktion besteht aus verzinkten Stahlprofilen. Die Behandlung der Oberfläche wird mit Pulverfarbe vollzogen. Die Sitz- sowie Tischplatte wurde aus tropischem Holz hergestellt.

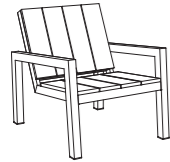

**LU140** 67,5 × 79 × 75 cm

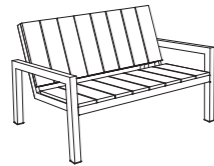

**LU240** 125,5 × 79 × 75 cm

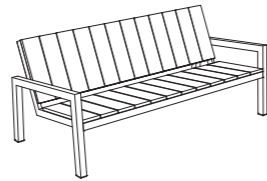

**LU250** 183,5 × 79 × 75 cm

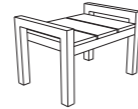

**LU100** 67,5 × 45 × 43 cm



**LU510** 48 × 45 × 37,5 cm

4x  
😊



**LU530** 90 × 45 × 37,5 cm

4-6x  
😊

# Leva

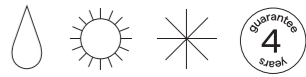

CZ Modulový systém Leva se skládá ze základní konstrukce a příslušenství. Všechny ocelové díly jsou povrchově dokončeny zinkem a práškovou barvou. Nosné trámy jsou z tvrdého a odolného dřeva. Příslušenství: – ocelový květináč, který je opatřen odtoky pro přebytečnou vodu – houpačí síť se skládá z bočních sítí, ocelového rámu pro rošt a outdoorového roštu s matracemi – střecha je vyrobena z outdoorové textilie. Jednotlivé příslušenství lze v modulech libovolně kombinovat. Jako doplněk lze zvolit outdoorové polštáře.

EN The Leva modular system is composed of from the base and accessories. All steel parts have zinc and powder coated surface finish. The support beams are made of hardwood and durable wood. Accessories: – steel pot with drains for excess water – hammock consisting of side meshes, a steel frame for the grate and the outdoor grate with mattresses – roof made of outdoor cloth Individual accessories can be combined in modules in any way. Outdoor pillows can be selected as an option.

DE Das modulare System Leva besteht aus der Grundkonstruktion und dem Zubehör. Alle Stahlteile sind oberflächlich verzinkt und mit Pulverfarbe vollendet. Die Stützbalken bestehen aus Hartholz und widerstandsfähigem Holz. Zubehör: – Ein Blumentopf aus Stahl, welcher mit einem Abfluss für überflüssiges Wasser versehen ist. – Die Hängematte besteht aus Seitennetzen, einem Stahlrahmen für den Rost und einem Outdoorrost mit Matratzen. – Das Dach wird aus einer Outdoor-Textilie hergestellt. Die einzelnen Zubehöerteile lassen sich beliebig miteinander kombinieren. Als Ergänzungsstück können Outdoorkissen gewählt werden.

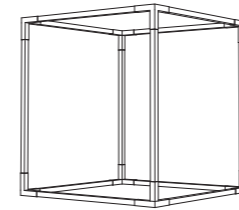

**LEV110** 220 × 220 × 240 cm

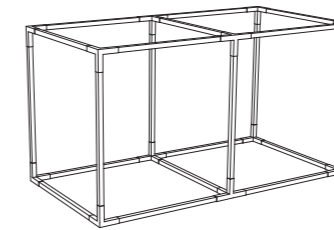

**LEV120** 437 × 220 × 240 cm

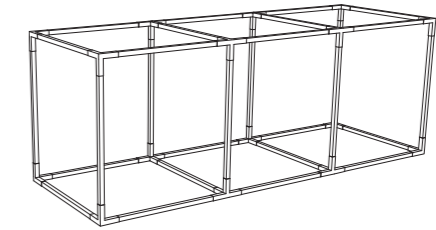

**LEV130** 652 × 220 × 240 cm

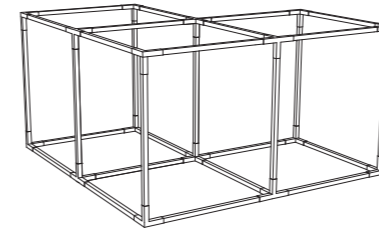

**LEV125** 437 × 437 × 240 cm

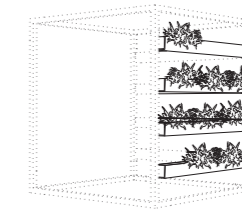

**LEV200** 208,5 × 15 × 19 cm

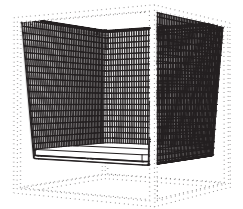

**LEV300** 190 × 190 × 190 cm

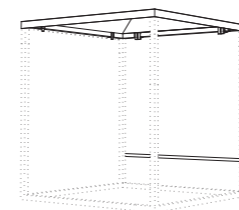

**LEV400** střecha 220 × 220 × 15 cm / bočnice 220 × 240 cm

# Limpido

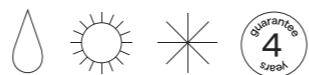

CZ Celooceľová konštrukcia je ošetrená proti korozi zinkom a povrchovú dokončena práškovou farbou.

EN Structure made of galvanized steel with powder coating finish.

DE Die Stahlkonstruktion wurde mit Zink gegen das Rosten behandelt und die Oberfläche mit Pulverfarbe beschichtet.



**LLP135** 51 × 75 × 80 cm

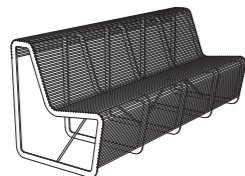

**LLP156** 200 × 75 × 80 cm



**LLP155** 150 × 75 × 80 cm

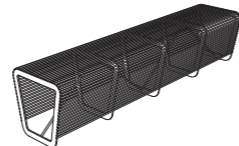

**LLP126** 200 × 44 × 44 cm



**LLP125** 150 × 44 × 44 cm

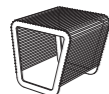

**LLP105** 51 × 44 × 44 cm

# Máj

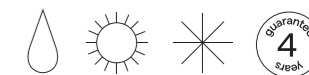

CZ Pozinkovaná oceľová konštrukcia je povrchovú dokončena práškovou farbou. Čalouněné sedáky včetně polštářů jsou vyrobeny z vysoce kvalitních outdoorových materiálů, proto mohou zůstat venku celou sezónu. Stolové desky stolků jsou vyrobeny z vysokotlakého laminátu (HPL).

EN Structure made of galvanized steel with powder coating finish. Upholstered seats and cushions made of quality fabrics, suitable for outdoor use. Table top made of high pressure laminate (HPL).

DE Die verzinkte Stahlkonstruktion wurde mit Pulverfarbe beschichtet. Die Polsterung von Sitzen sowie die Kissen wurden aus hochwertigem Outdoor-Material hergestellt, deshalb können sie die ganze Saison draussen bleiben. Die Tischplatten wurden aus Hochdrucklaminat (HPL) hergestellt.



**MA104** 100 × 67 × 32 cm



**MA105** Ø 70 × 32 cm



**MA106** Ø 70 × 52 cm



**MA103** Ø 33 × 55 cm

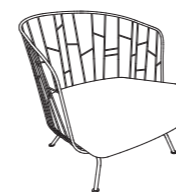

**MA102** 77 × 73 × 76,5 cm

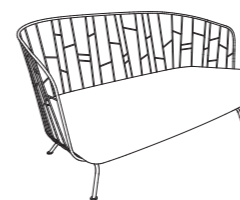

**MA100** 150 × 76 × 78 cm

# Mario

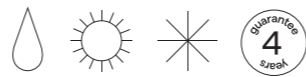

CZ Konstrukce je vyrobena z pozinkovaných ocelových pásovin a plechu, dokončených práškovou barvou. Lamely různých délek nabízíme ve variantě akátu.

EN The structure is made of galvanized steel strips and steel sheets with a powder coated surface finish. We offer slats in various lengths in the acacia variant.

DE Die Konstruktion wird aus verzinkten Barren und Blech hergestellt, welche anschliessend noch mit Pulverfarbe fertiggestellt werden. Die Lamellen der verschiedenen Längen bieten wir im Akazienholz an.



**MAR110** 69 × 45 × 100 cm

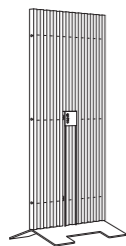

**MAR120** 69 × 45 × 155 cm



**MAR130** 69 × 45 × 210 cm

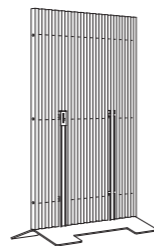

**MAR220** 99 × 45 × 155 cm

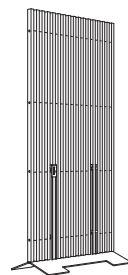

**MAR230** 99 × 45 × 210 cm

# Mini vera

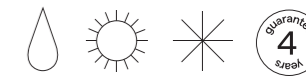

CZ Pozinkovaná ocelová konstrukce je povrchově dokončena práškovou barvou. Sedací část židlíček a laviček nabízíme v tropickém dřevě a akátu. Opěradlovou část si můžete zvolit dřevěnou nebo z vysokotlakého laminátu (HPL). Stolové desky stolků jsou vyrobeny z vysokotlakého laminátu (HPL).

EN The zinc-coated steel structure has a powder coated finish. The seats of chairs and benches can be made of tropical wood and acacia. For the backrest part, you can choose from wood or high-pressure laminate (HPL). The table boards are made out of high-pressure laminate (HPL).  
DE Die verzinkte Stahlkonstruktion

ist mit Pulverfarbe oberflächlich behandelt. Die Sitzfläche des Stuhles und der Bank bieten wir in tropischem Holz oder Akazienholz an. Die Lehne können Sie aus Holz oder aus Hochdrucklaminat (HPL) auswählen. Die Tischplatten werden aus Hochdrucklaminat (HPL) hergestellt.



**LVE150** 100 × 47 × 56 cm



**LVE152** 35 × 47 × 56 cm



**LVE160** 100 × 47 × 55,5 cm



**LVE162** 35 × 47 × 55,5 cm



**LVE920** 120 × 70 × 53 cm

4-6x  
😊



**LVE930** 70 × 70 × 53 cm

4x  
😊

# Moja

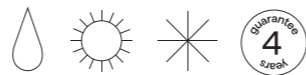

CZ Ocelová konstrukce je pozinkovaná a povrchově dokončena práškovou barvou. Na opěradlovou část a podnožku je použita outdoorová síťovina Batyline. Čalouněné sedáky s područkami jsou vyrobeny z vysoce kvalitních outdoorových materiálů.

EN The steel structure is galvanized and has a powder coated surface. The backrest and the footrest use the Batyline outdoor mesh. Upholstered seats and armrests are made of high-quality outdoor materials.

DE Die Stahlkonstruktion ist verzinkt und oberflächlich mit Pulverfarbe fertiggestellt. Für die Lehne und den Hocker wird die Outdoor - Textilie Batyline verwendet. Die gepolsterten Sitze werden aus hoch qualitativen Materialien hergestellt.

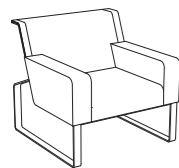

**MO110** 80 × 80 × 79 cm

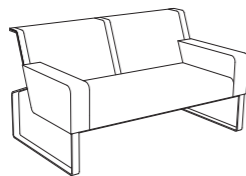

**MO120** 145 × 80 × 79 cm

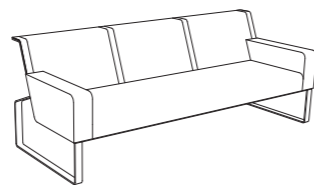

**MO130** 215 × 80 × 79 cm

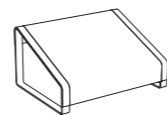

**MO200** 80 × 59 × 40 cm

78 ←

# Preva

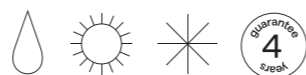

CZ Konstrukce je vyrobena z pozinkovaných pásovin, které jsou povrchově dokončeny práškovou barvou nebo z nerez. Sedací i opěradlová část je z tropického dřeva nebo akátu. Křeslo je doplněno o dva podhlavníky z PUR a outdoorové síťoviny Batyline; lze doplnit i o změkčovadla. Z vysokotlakého laminátu (HPL) jsou vyrobeny područky obou křesel.

EN Galvanized steel structure with powder coating finish or stainless steel. Seat and backrest made of tropical wood or acacia. The armchair is completed with two cushions made of PUR foam covered with the Batyline outdoor fabric. Armrests made of HPL.

DE Die Konstruktion wurde aus verzinkten Stahlbändern hergestellt, dessen Oberfläche mit Pulverfarbe beschichtet wurde. Die Sitzfläche sowie Rückenlehne wurde aus tropischem Holz oder Akazienholz hergestellt. Der Sessel wurde mit zwei Kopfstützen aus PUR- Schaum und Outdoor- Batyline ergänzt. Die Armlehnen der beiden Sessel wurden aus Hochdrucklaminat (HPL) hergestellt.



**LP355** 63,5 × 105 × 78 cm

**LP355n** 63,5 × 105 × 78 cm



**LP375** 66,5 × 71 × 80 cm

**LP375n** 66,5 × 71 × 80 cm



**LP365** 63,5 × 58,5 × 26,5 cm

**LP365n** 63,5 × 58,5 × 26,5 cm

84 ←

# Radium

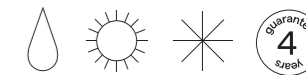

CZ Konstrukce je pro odlehčení vyrobena z hliníkového plechu, který je povrchově dokončený práškovou barvou. Sedací i opěradlová část je vyrobena z tropického dřeva, akátu nebo HPL.

EN Structure made of aluminum sheet with powder coating finish. Seat and backrest made of tropical wood, acacia or HPL.

DE Um die Konstruktion zu erleichtern, wurde sie aus Aluminiumblech hergestellt, welches anschliessend oberflächlich mit Pulverfarbe behandelt wurde. Die Sitzplatte und Rückenlehne ist in den Varianten tropisches Holz, Akazienholz oder HPL erhältlich.

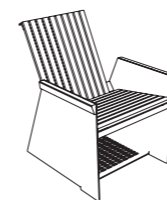

**LRE350** 60 × 72 × 85 cm

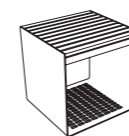

**LRE115** 45 × 42 × 43 cm

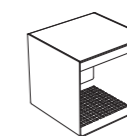

**LRE450** 45 × 42 × 43 cm

90 ←

# Salto

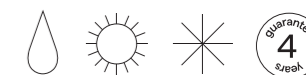

CZ Konstrukce je vyrobena z oceli, která je pozinkovaná a následně povrchově dokončena práškovou barvou. Nohy věšáku a němého sluhu jsou z tropického dřeva nebo akátu.

EN The main part of the furniture is made of zinc-coated steel with a powder coated finish. The legs of the coat rack and the valet stand are made of either tropical wood or acacia.

DE Die Konstruktion wurde aus Stahl hergestellt, welcher verzinkt ist und anschliessend mit Pulverfarbe behandelt wurde. Die Beine sind aus tropischem Holz oder aus Akazienholz.



**SAL200** 49 × 57 × 118 cm

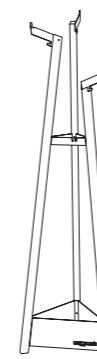

**SAL100** 52 × 45 × 184,5 cm

96 ←

# Sena

CZ Celodřevěné stoly jsou vyrobeny z tropického dřeva, na přání mohou být ošetřeny teakovým olejem. Stolové desky mohou být i ve variantě HPL.

EN Solid wood tables made of tropical wood, may be treated with teak oil upon request. Table tops may be chosen in HPL variant, too.

DE Die hölzernen Tische wurden aus tropischem Holz gefertigt. Auf Wunsch kann die Oberfläche mit Teak-Öl behandelt werden.

+ Doporučujeme kombinovat s těmito produkty

We recommend to combine them with these products

Wir empfehlen die Kombination mit diesen Produkten.

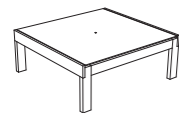

**SN121** 100 × 106 × 40 cm

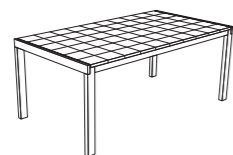

**SN100** 178,5 × 85 × 75 cm

+ Cora + Tina + Bistrot  
+ Limpido

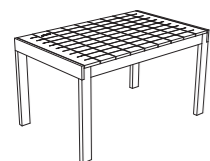

**SN102** 135 × 85 × 75 cm

+ Cora + Tina + Bistrot  
+ Limpido

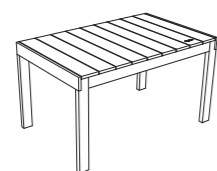

**SN112** 135 × 85 × 75 cm

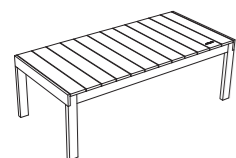

**SN113** 178,5 × 85 × 60 cm

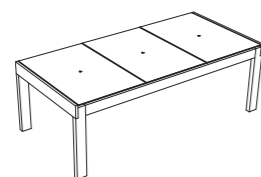

**SN123** 178,5 × 85 × 60 cm

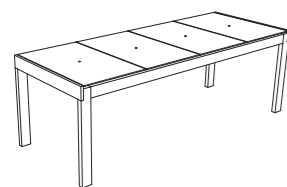

**SN125** 220 × 85 × 75 cm

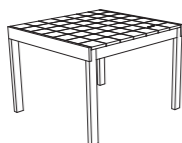

**SN106** 100 × 106 × 75 cm

+ Cora + Tina + Bistrot  
+ Limpido

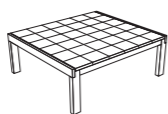

**SN101** 100 × 106 × 40 cm



**SN110** 178,5 × 85 × 75 cm

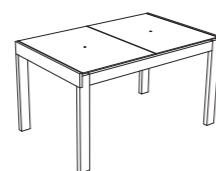

**SN122** 135 × 85 × 75 cm



**SN105** 220 × 85 × 75 cm

+ Cora + Tina + Bistrot  
+ Limpido

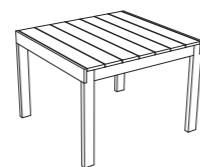

**SN116** 100 × 106 × 75 cm



**SN111** 100 × 106 × 40 cm

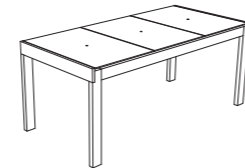

**SN120** 178,5 × 85 × 75 cm

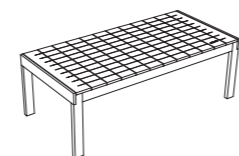

**SN103** 178,5 × 85 × 60 cm



**SN115** 220 × 85 × 75 cm

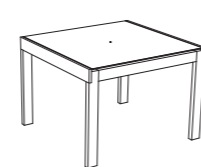

**SN126** 100 × 106 × 75 cm

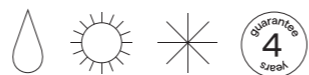

# Sombra

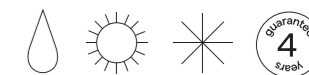

CZ Dřevěná konstrukce je vyráběna z tvrdého a odolného dřeva. Všechny ocelové díly jsou povrchově dokončeny zinkem a práškovou barvou. Velikostní varianty je možné doplnit o zástěny, gril, posuvné dveře, vrata, popínavé rostliny a konzolu.

EN The wooden structure is made of hard and durable wood. All steel parts are surface-finished with zinc and powder coating. You can supplement the available size variants with screens, a grill, a sliding door, a gate, climbing plants and a console.

DE Die Holzkonstruktion wird in hartem und widerstandsfähigem Holz angeboten. Alle Stahlteile sind oberflächlich mit Zink und Pulverfarbe behandelt. Die verschiedenen Grössenvarianten können mit einer Schutzwand, einem Grill, einer Schiebetüre, einem Tor, mit Schlingpflanzen oder einer Konsole erweitert werden.

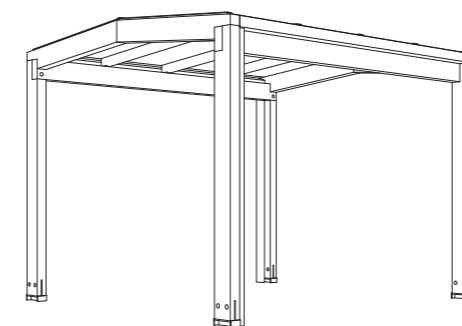

**SOD110** 300 × 300 × 265 cm

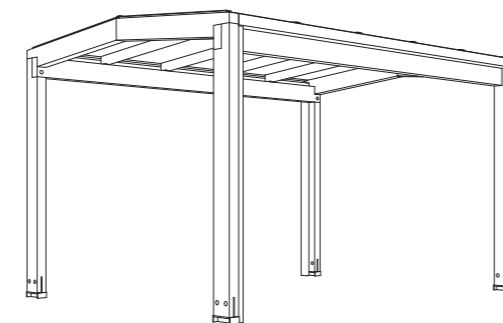

**SOD120** 400 × 300 × 265 cm

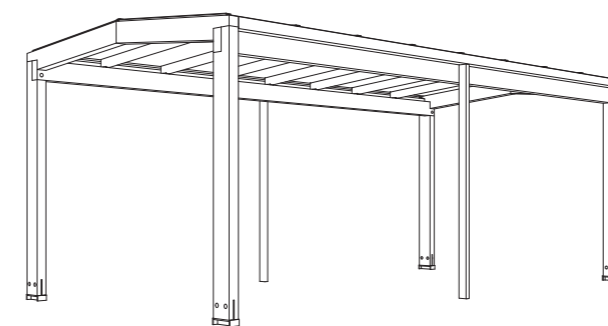

**SOD130** 600 × 300 × 265 cm



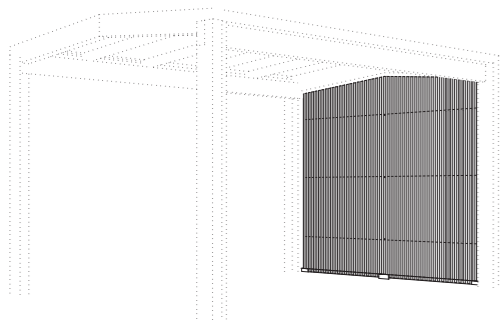

SOD boční zástěna / side screen / Seitenwand

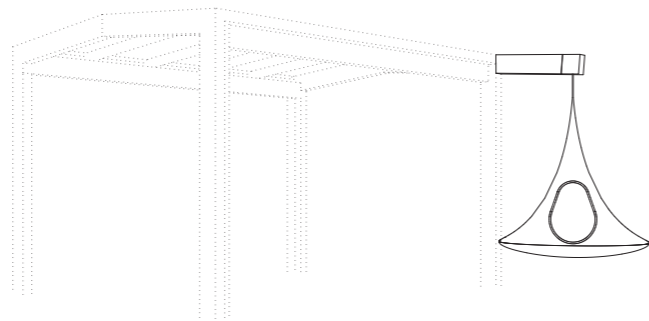

SOD cocoon

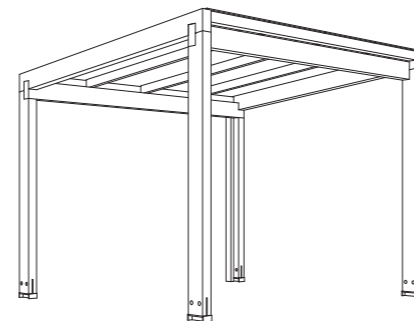

SOP110

300 × 300 × 279 cm

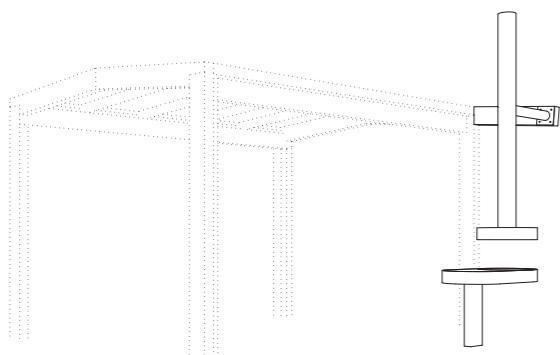

SOD grill

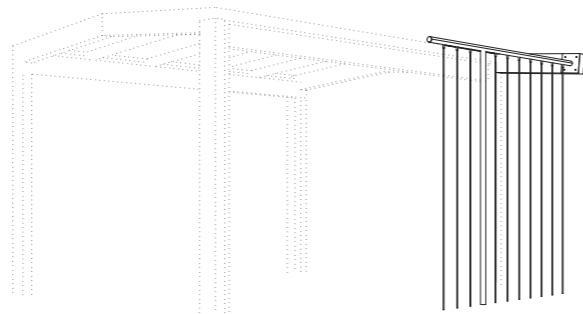

SOD popínavka / trellis / Schlingpflanze

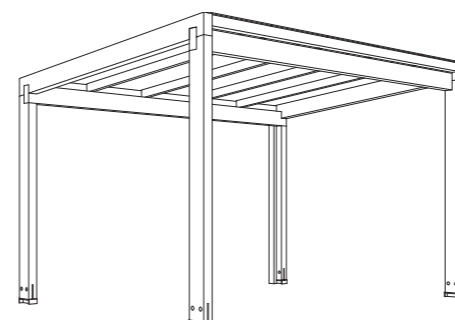

SOP120

400 × 300 × 279 cm

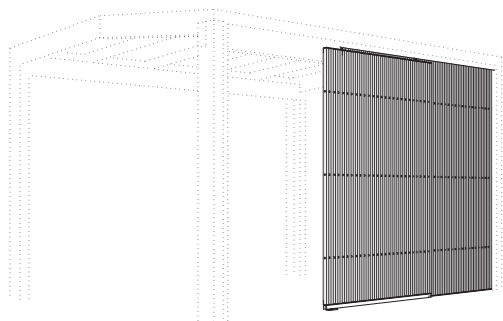

SOD posuvné dveře / sliding door / Schiebetüre

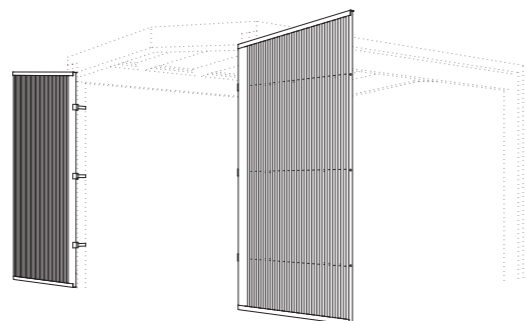

SOD vrata / gate / Tor

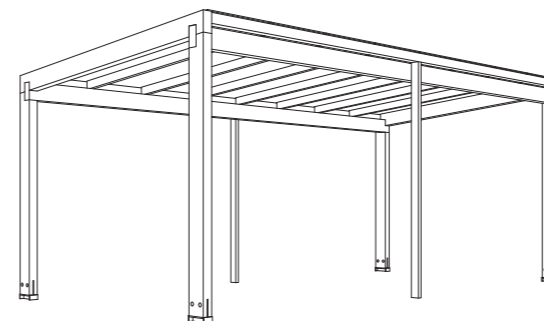

SOP130

600 × 300 × 279 cm

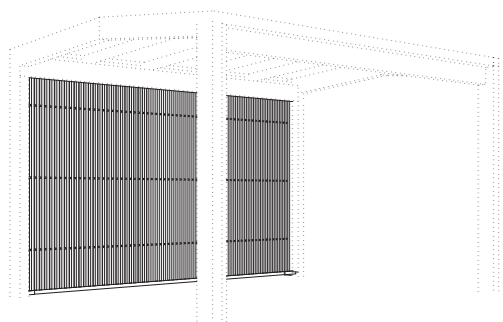

SOD zadní zástěna / back screen / Rückwand

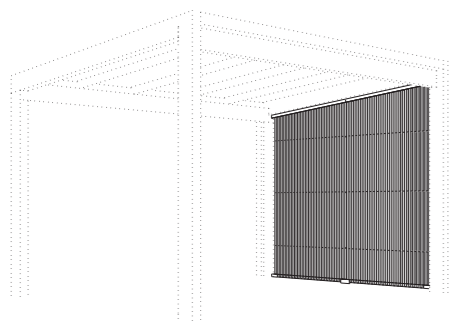

SOP boční zástěna / side screen / Seitenwand

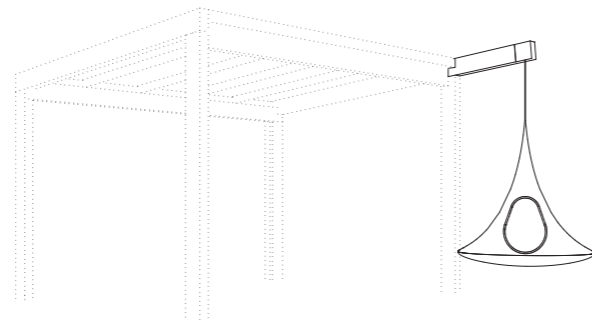

SOP cocoon

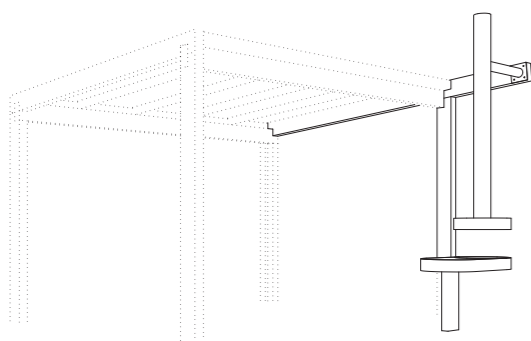

SOP gril

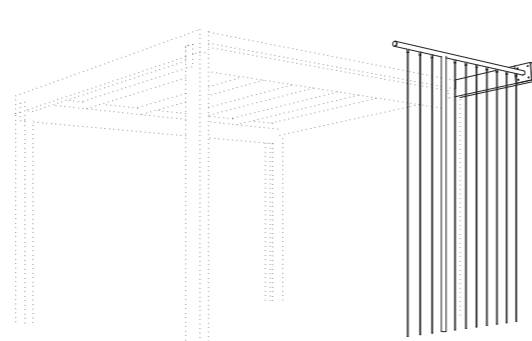

SOP popínavka / trellis / Schlingpflanze

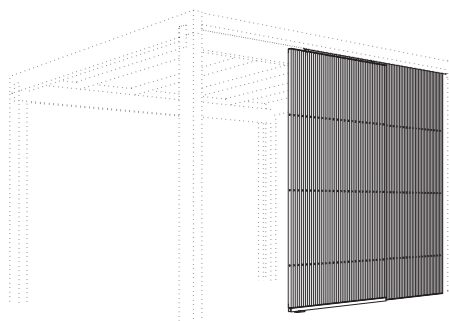

SOP posuvné dveře / sliding door / Schiebetüre

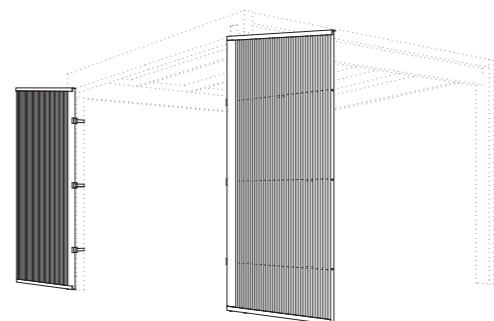

SOP vrata / gate / Tor

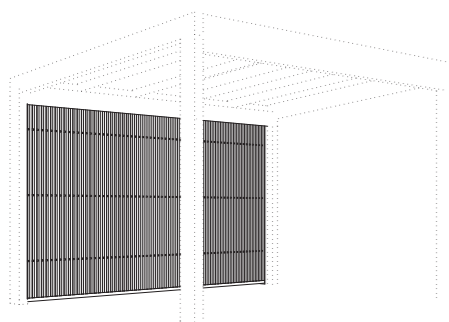

SOP zadní zástěna / back screen / Rückwand

# Tina

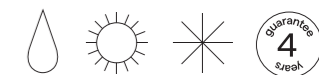

CZ Konstrukce je vyrobena z pozinkovaných trubek a povrchově dokončena práškovou barvou. Varianty sedáků lze zvolit z tropického dřeva, akátu nebo ocelových kulatinek, které lze doplnit outdoorovými pěnovými průplety.

EN Structure made of galvanized steel tubes with powder coating finish. The options for the seating are: tropical wood, acacia or steel rods that can be completed with softeners made of outdoor foam.

DE Die Konstruktion wurde aus verzinkten Stahlrohren hergestellt und mit Pulverfarbe beschichtet. Das Material kann aus verschiedenen Varianten ausgesucht werden: Tropisches Holz, Akazienholz oder Rundstahlstäbe, welche man mit verflochtenen Outdoor-Schaumstoff-Streifen ergänzen kann.



KL100 49,5 × 56 × 86,5 cm



KL102 49,5 × 56 × 86,5 cm



KL103 49,5 × 56 × 86,5 cm



KL104 52 × 56 × 86,5 cm



KL105 49,5 × 56 × 45 cm



KL106 100 × 100 × 76 cm

4x

déšť / rain / Regen



sluneční záření / sun  
rays / Sonnenschein



sníh / snow / Schnee



záruka / warranty /  
Garantie



stohovatelnost /  
stackable /  
Stapelbarkeit



počet lidí u stolu /  
no. of persons at  
the table / Anzahl  
Personen am Tisch



concept studio plusko  
design Andrea Vacovská, Zuzana Lednická (Studio Najbrt)  
production studio plusko  
photography Dušan Tománek  
© 2017

egoé s.r.o.  
Bílovice 519, 687 12 Bílovice Czech Republic  
info@egoe.cz, www.egoe.cz



outdoor furniture  
[www.egoe.cz](http://www.egoe.cz)